



Bronto Skylift S-HLA

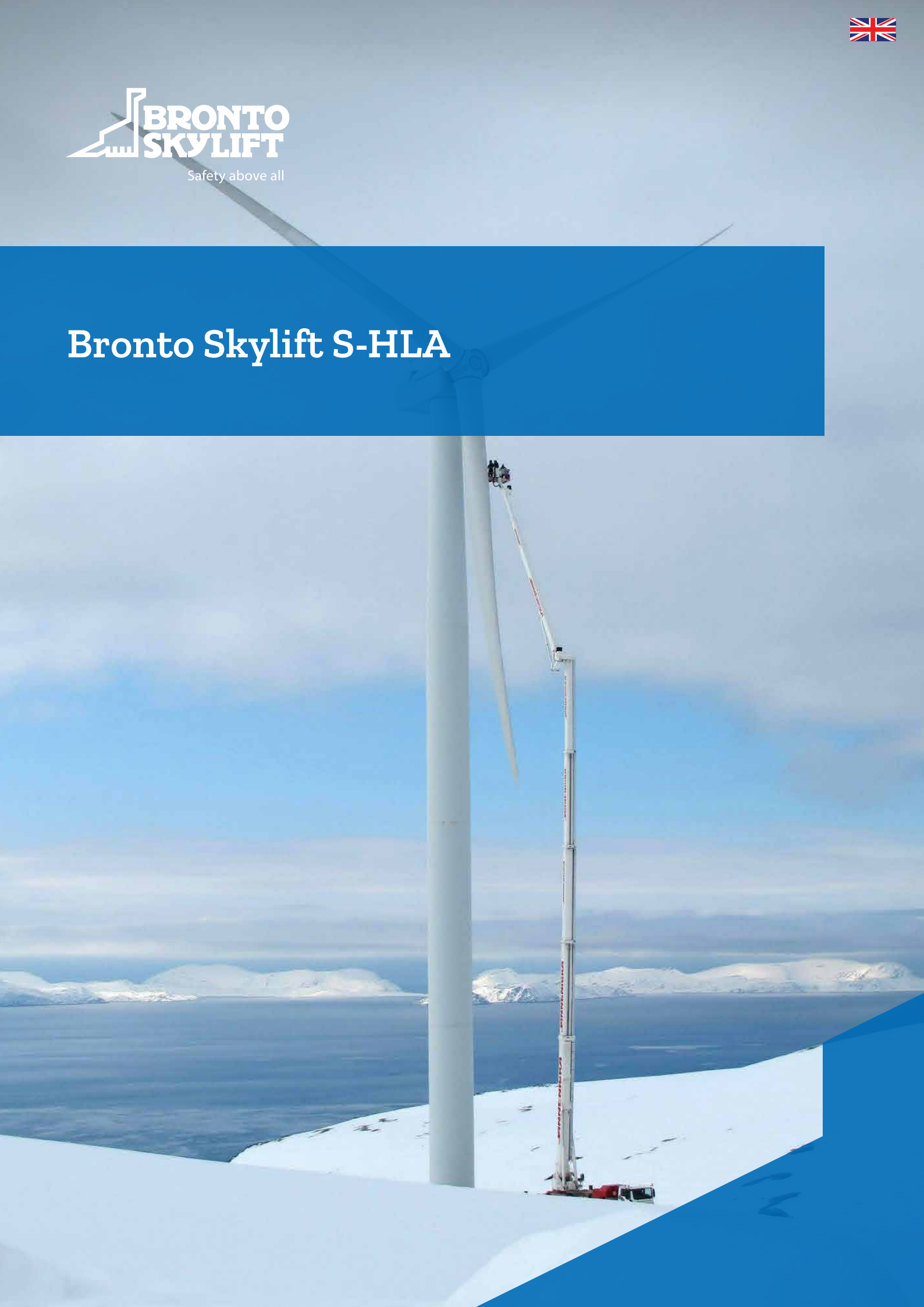



Photo by Santeri Keränen, IAPA Photo of the year 2019

The highest of truck-mounts

We believe in continuous improvements and are always aiming higher in our mission to provide the best solution for professionals working at heights. The HLA-range represents the ultimate in high rise access.

This range includes the world's highest truck-mounted platforms, offering maximum vertical and horizontal outreach combined with the best height-to-weight ratio on the market. The HLA provides secure stability and easy manoeuvrability in different conditions and environments.

It's not just about how high you can go, but also how safely you do it. And as always, your safety is of paramount importance. With Bronto Skylift platforms you can get where you need to be, and return home safely.

HLA key features

- Working height from 90 to 112 meters
- Working outreach up to 33 meters
- Maximum cage load of 700 kg
- Easy to use and precise Bronto+ control system
- Lifetime support to maintain high resale value





Extremely reliable outreach, easy-to-use control system and precise movements.

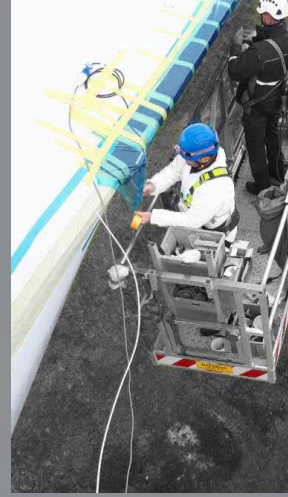

Unmatched cage at maximum height.



Rain, shine, wind or snow – made to last in all conditions.



Various options, from various cages and material handling devices to power outlets in the cage.

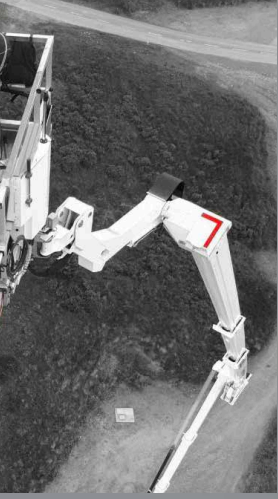

Large stability, even heights.



Short overhang, excellent approach angles and an efficient height-to-weight (GVW) ratio.

RECORD



Fast and simple set-up. You get up in the air within minutes.







Modern service tools and a wide service network to guarantee the best possible uptime.

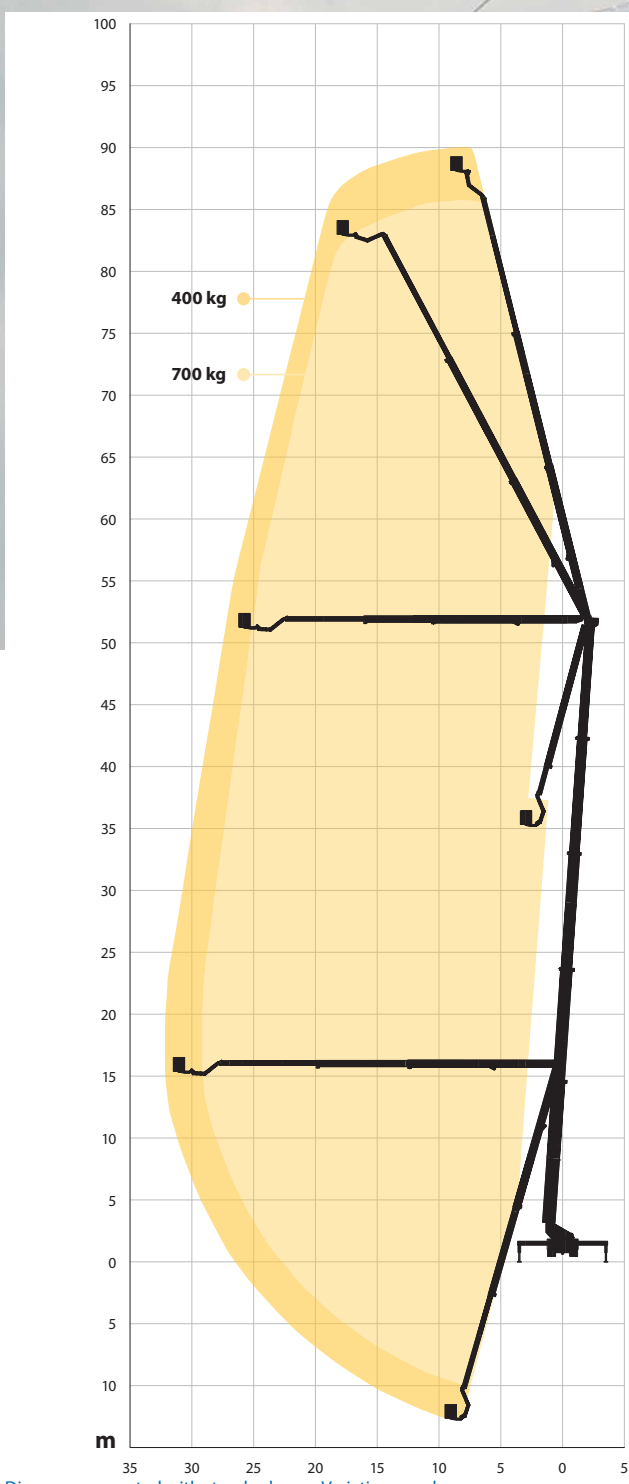
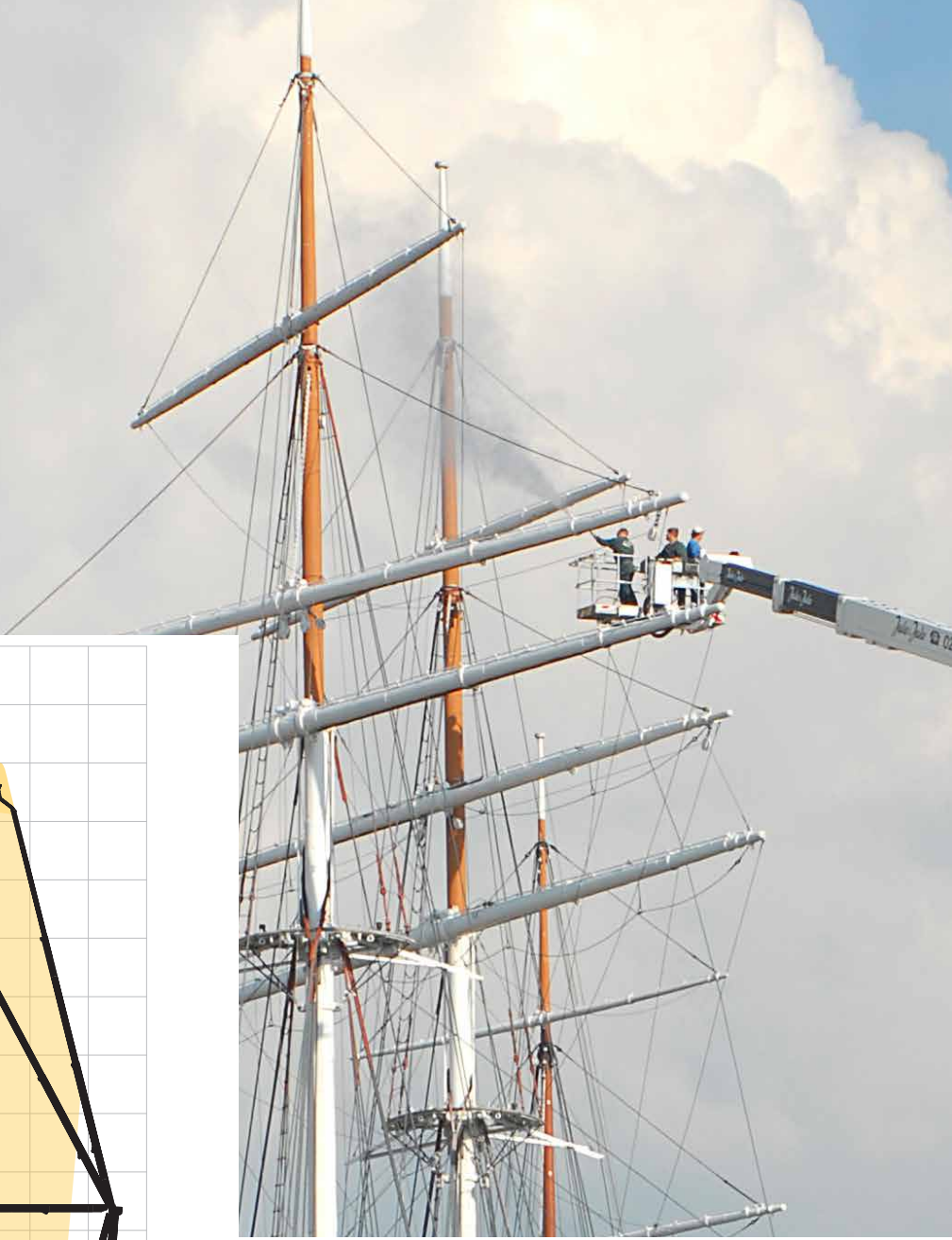

S90HLA



-  **90 m**
-  **32 m**
-  **88 m**
-  **700 kg**
-  **1,1 x 2,4 m (3,7 m²)**

Diagrams presented with standard cage. Variations apply.

* depending on chassis

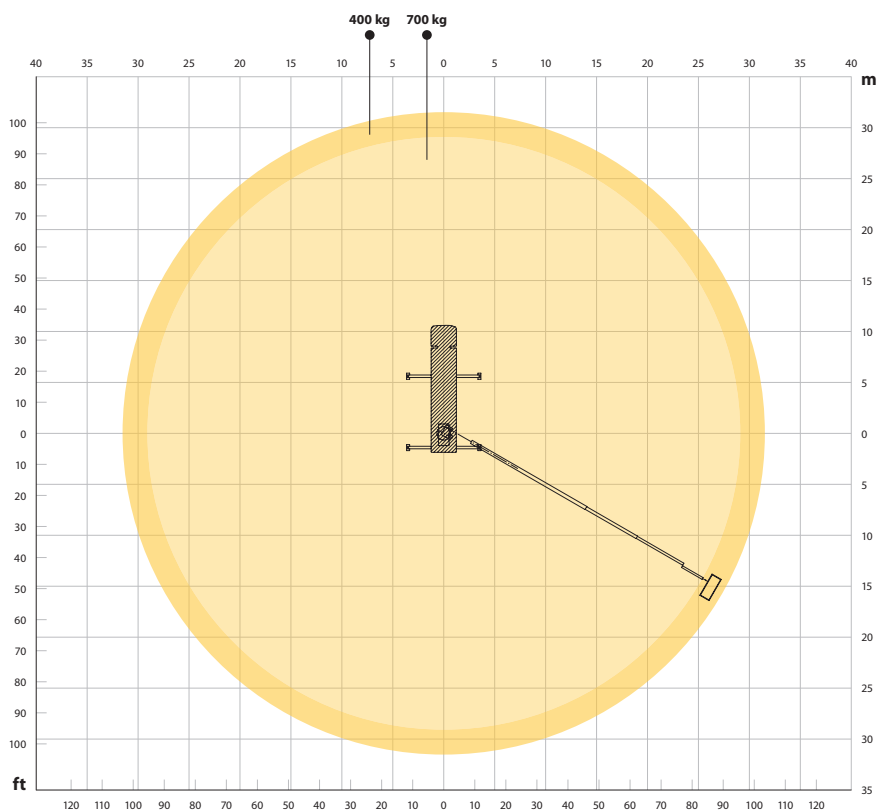

 **2 x 85°**

 **360°**

 **4 m***

 **15.5 m***

 **48 t***

Diagrams presented with standard cage. Variations apply.

* depending on chassis

S104HLA

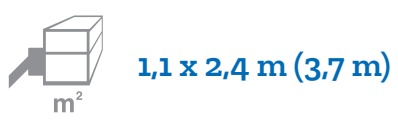
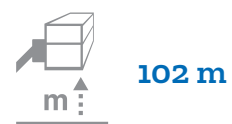
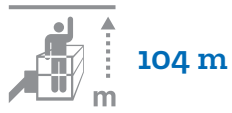
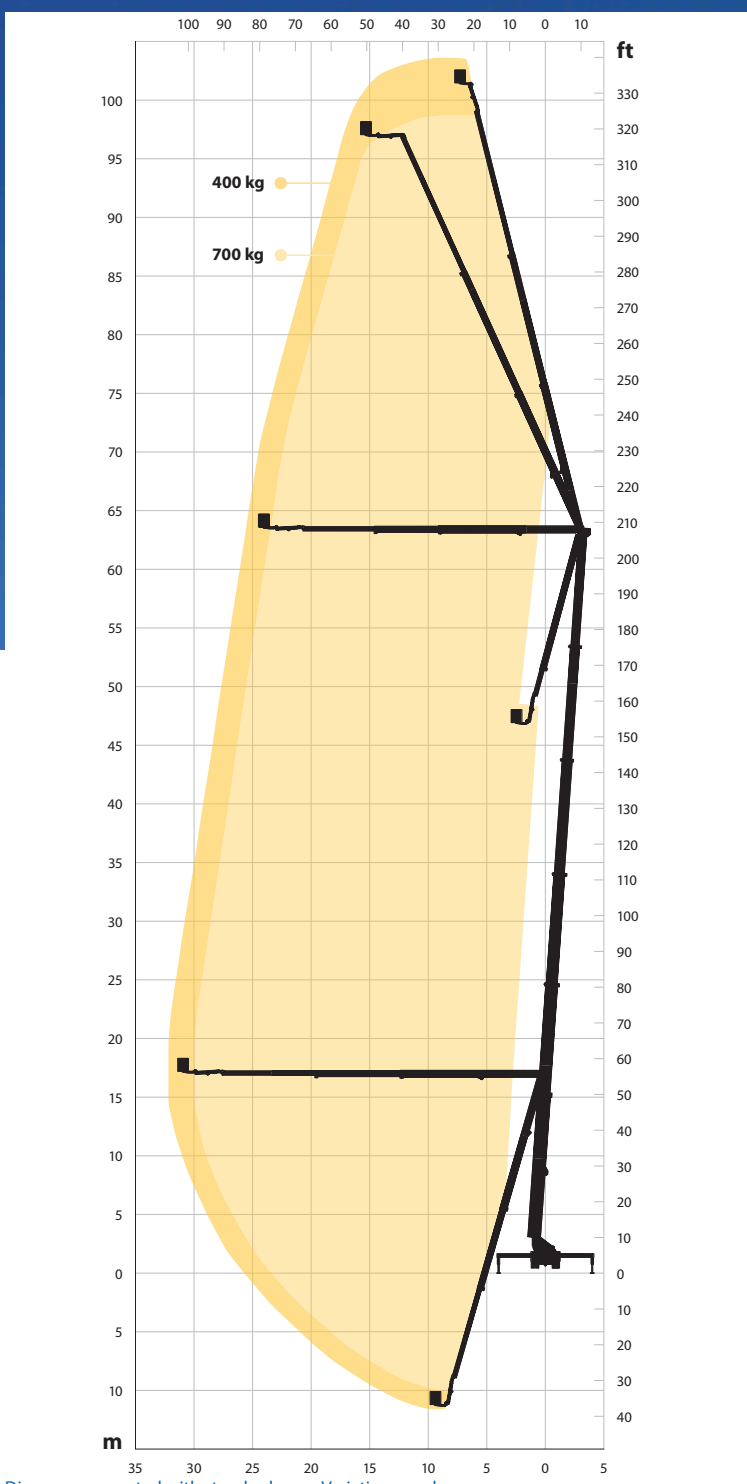

Diagrams presented with standard cage. Variations apply.

* depending on chassis

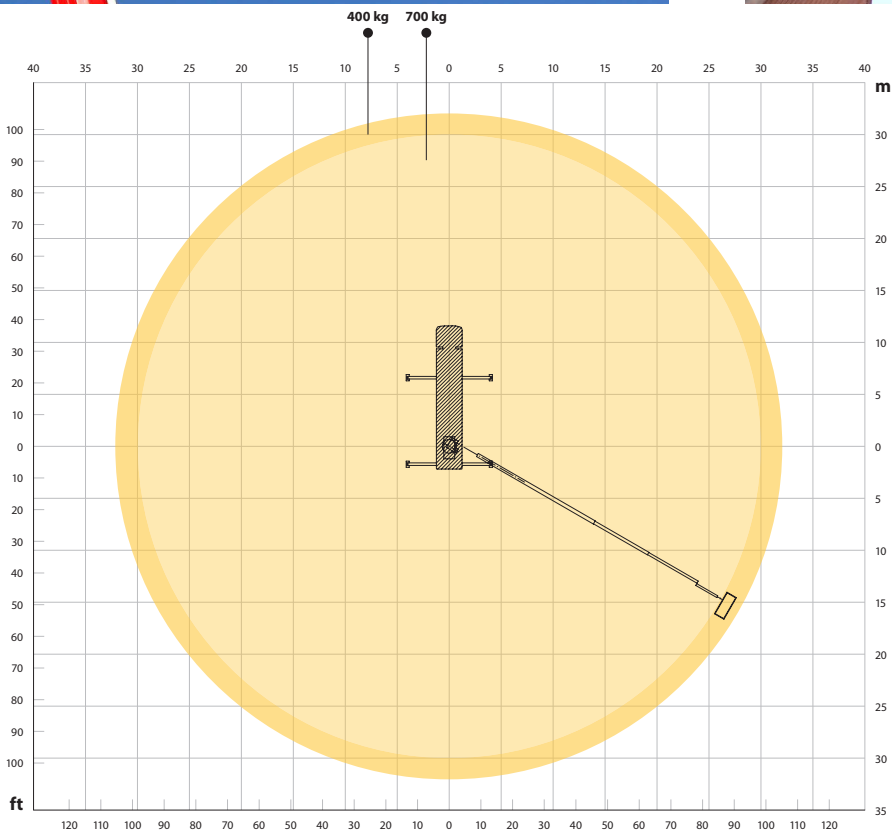

2 x 85°



360°



4 * m



16,3 m *



62 t *

Diagrams presented with standard cage. Variations apply.

* depending on chassis

Standard

Available

Not available

OPTIONS, SIMPLIFIED SELECTION	S XR	S XDT	S HLA	S EM
DECKING AND STEPS				
Aluminium sides on the decking				
Additional sidelights (Sidelights R48 ECE as std)				
Recessed foldable step, left/right				
Pull out step for rear of the platform, left/right				
Ladder type step with railings, left/right				
LOCKERS AND SIDEPANELS				
Complete locker for outrigger controls				
Tool box below decking				
Aluminum lockers with roller shutters				
Timber rack, mounted below decking				
GROUND PADS AND BRACKETS				
4 ground pads with aluminium brackets				
Conductive ground pads				
4 round ground pads insted of std pads				
JACKING SYSTEM				
Automatic, fully variable jacking				
Bronto Loadman for measuring the bearing capacity of ground				
Radio remote control for outriggers				
BACK-UP SYSTEMS FOR HYDRAULICS				
Petrol emergency back-up system by Kohler engine				
Petrol emergency back-up system by Kohler engine, electric start				
Diesel emergency back-up system by HATZ 1D81C silenced, electric start/stop				
Electric emergency back-up system by a battery pump				
Electric motor drive for the hydraulics				
MAIN DRIVE ENGINES				
Hydraulic pump driven by chassis' PTO				
Diesel engine HATZ 4H50TIC Semi-Silent				
POWER/AIR/WATER SUPPLY AND OUTLETS				
Electricity between turntable and cage, different voltages available				
Air/water supply between the turntable and cage				
Hydraulic outlets in the cage				
Hydraulic outlets and pressure intensifiers				
INTERCOM AND RADIO				
Intercom between the cage and ground control station				
GENERATORS				
Hydraulic generator with different power outputs				
CAGES AND ACCESSORIES				
Tree cutter fence for the cage				
Finger protection railing				
Ultra sonic collision guard with four sensors				
Cage rotation $\pm 220^\circ$ (S47XR only with std rotation $\pm 90^\circ$)				
Safety harness attachment points (4pc) according to EN795				
Working cage 1,05 x 2,4 x 1,1 m, SWL 700 kg				
Extendable working cage 1,05 x 2,4 (-3,7) x 1,1 m, SWL 600kg				
Rotating camera cage				
Extendable working cage 0,9 x 2,4 (-3,4) x 1,1 m, SWL 350kg				
Working cage 0,9 x 2,04 x 1,1 m, SWL 500 kg				
Wide working cage 0,9 x 2,40 x 1,1 m, SWL 450 kg				
Lighting rig, SWL 300 kg				
RF Antenna rig, width 5,7 m, SWL 50kg				
Cage floor heating				
Working cage extension module, 1,0 m, capacity 100kg				
MATERIAL HANDLING				
Detachable winch in the working cage, SWL 400 kg, 2 fold out feet for the load (200kg/each)				
Element lifting system, capacity 150 kg.				
Mast section lifter, capacity 150 kg				
Intelligent lifting eye mounted on to the last section of the main boom, max. load 2200 kg				
TURNTABLE CONTROL STATION				
Full lower control station at the turntable				
BRONTO+ CONTROL SYSTEM				
Engine information and warnings on display				
Telecontrol or Compass remote connection (for warranty period, optional after that)				
Memory function, height and outreach limitations and different user profiles				
Wireless remote control for boom movements				
Service counter and reminders				
Continuous rotation 360°				
High Voltage detector				
BEACONS AND LIGHTS				
Various LED warning beacons and flashing lights				
Various working lights 24V				
CHASSIS				
Reversing camera with 7" color display in the cabin				
Battery charger (DEFA) 2x20A, suitable for battery sizes up to 500Ah				
MISCELLANEOUS				
Safety Rail System, one rail on one side, without harness or self-retracting reel				



Added safety and efficiency

High safety does not decrease the efficiency, it does the opposite.

Control system for added safety and ease

Safety is about creating a safer working environment. An advanced control system increases the safety on your worksites by letting you focus on the job at hand.

The unit includes the Bronto+ control system, which provides precise and stable movements and is very simple and smooth to operate.

Thanks to a geometry-based, fully automatic outreach control system, you can be sure of reaching your targets every single day, regardless of rain, shine or wind.

Feel it in your fingers

The rugged HLA platforms will keep you steady and allow you to do the job you are up there for. Even at maximum height or outreach, the cage has unmatched stability.

To get the job done efficiently, in addition to a steady cage you need a control system that gets you close enough every time. The movements of a Bronto platform are extremely precise. Great performance and great heights, all at your fingertips.





It's all about the uptime

With the Bronto Skylift service tools you can maximise your uptime and reduce maintenance cost.

We back you up

We want your machines to run at the best possible rate and keep their residual value. That's why we back you up from the first day throughout your platform's life cycle. When buying a new Bronto Skylift unit, you can trust that its spare parts will be available for at least the next 25 years.

Advanced remote support

We may not always be there with you, but we are always there for you. When you need accurate real-time problem-solving in an unexpected situation, a versatile remote diagnostics system allows our service professionals to open a connection with your Bronto. Faults and their causes can then be rapidly identified, analysed and corrected, limiting downtime and reducing unnecessary costs.

Service agreements

With the Bronto Service agreement, you can be sure your Bronto equipment is kept in the best possible shape for its entire life cycle. The content of our mutual agreement is fully customised according to your needs and wishes. The widest service network in the industry keeps you backed up wherever you are.

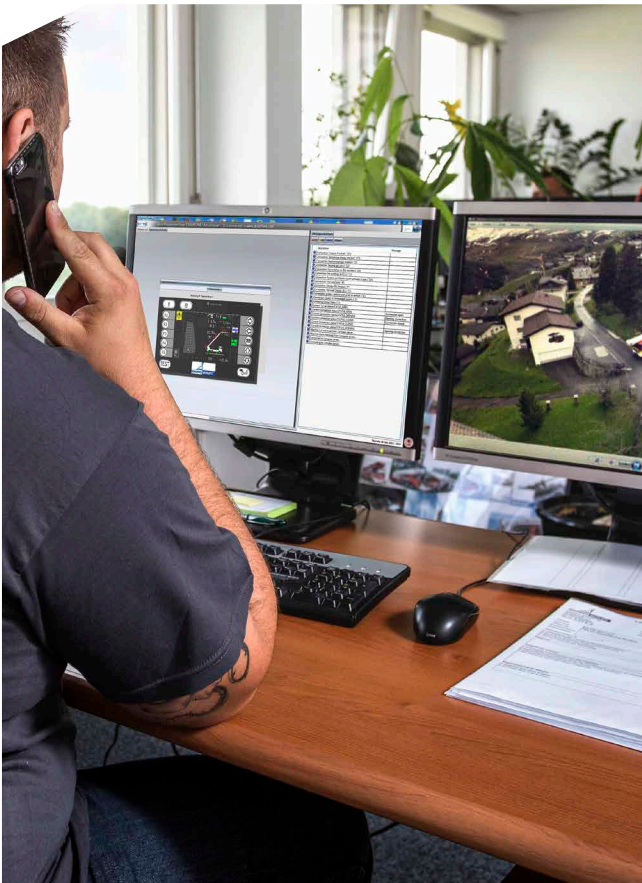



Bronto One

More than fleet management

Bronto One is a cloud-based portal for managing fleets and operations – a single source for all critical information. It's your single point of entry to Bronto Skylift's lifecycle services, wherever you are.

Available in three levels, Basic, Plus and Pro, Bronto One includes features from fleet management, training, worksite planning, reporting and more to streamline your operations for best performance. Basic level is free for everyone with a Bronto aerial platform in their fleet.



Bronto One®

Basic

Plus

Pro

Bronto One Basic

Bronto One Basic provides you with an overview of your Brontos by consolidating basic unit information, manuals, info bulletins and service logs into one online hub. Get easy, instant access to these digital materials across your organisation – anytime, anywhere.

Bronto One Basic is free for all Bronto Skylift’s customers.



Bronto One Plus

Bronto One Plus enables the usage data and analytics, as well as remote access to your aerial(s) for fast and accurate remote support. The usage data, analytics and insights help you reduce emissions, optimise fleet usage, and plan preventive services for maximum uptime.

Bronto One Plus is free during your warranty period.

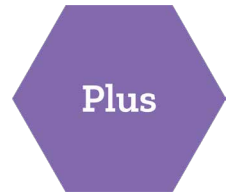

Bronto One Pro

Bronto One Pro includes all the features in Bronto One Plus but expands on them with a powerful suite of worksite management and planning tools. It makes worksite information easily available in the office and at the worksites and provides you with powerful 3D planning tool, Bronto Duties.



	Basic – Free	Plus	Pro
Basic unit info, Manuals, Bulletins, Service logs	x	x	x
Support centre	x	x	x
Remote access*		x	x
Fleet usage, analytics & insights**		x	x
Service plans		x	x
Worksite management and planning, incl. duties and available BIM models			x
Document management			x
Key benefits	<ul style="list-style-type: none"> • Bronto unit information • Manuals, service logs and info bulletins • Support centre 	<ul style="list-style-type: none"> • Remote access • Usage data, analytics, insights • Training management 	<ul style="list-style-type: none"> • Worksite management • 3D worksite planning • Document management

* Only to units with Bronto+ control system

** Only for Bronto 4+ & Bronto 5+ control systems

Bronto Skylift is a trusted global supplier of truck-mounted hydraulic platforms. We design, manufacture, sell and service appliances for rescue and firefighting, as well as for industrial access.

Our product range includes approximately 50 models with a range of 17 to 112 metres of working height. The advanced modularity also allows for numerous client-specific modifications. During the past 50 years, we have delivered over 7,000 platform units to fire brigades and industrial customers throughout all the continents in more than 120 countries.

Our headquarters and production plants are situated in Finland. We also have subsidiaries in Germany, Sweden, Switzerland and the US. The company is part of the Japan-based Morita Holdings Corporation.

sales@brontoskylift.com

Technical data and illustrations subject to change without notice.

www.brontoskylift.com